

ADD Plus O F

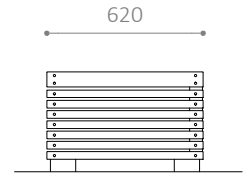

ADD Plus O N

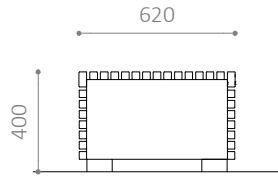
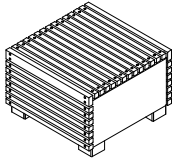
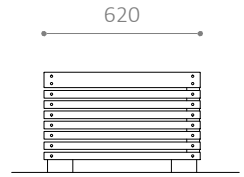
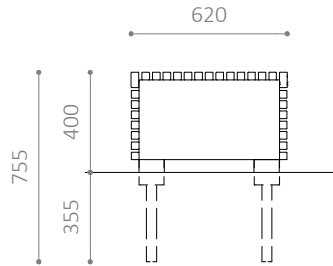
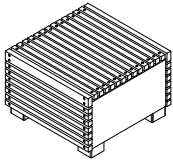

ADD Plus S F

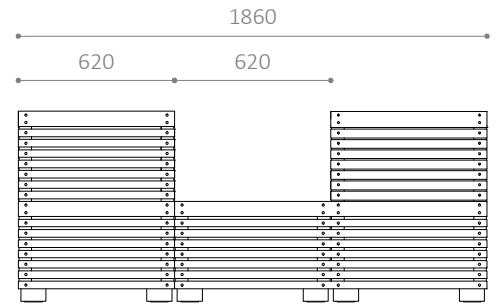
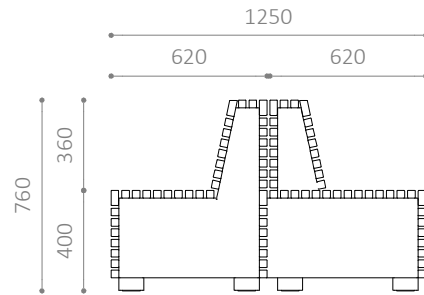
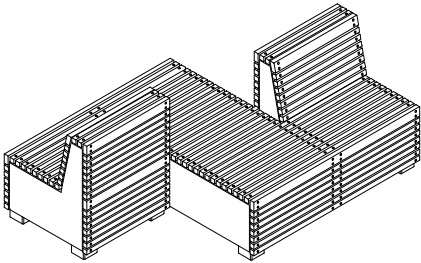

ADD Plus S N

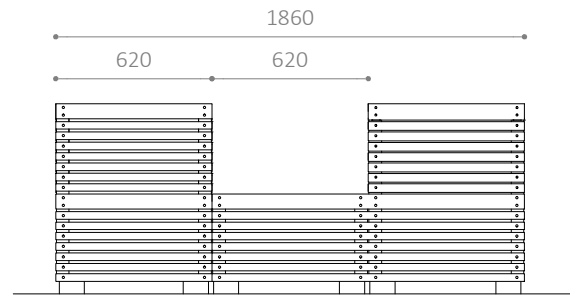
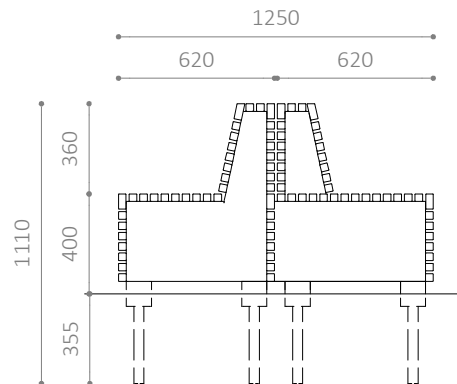
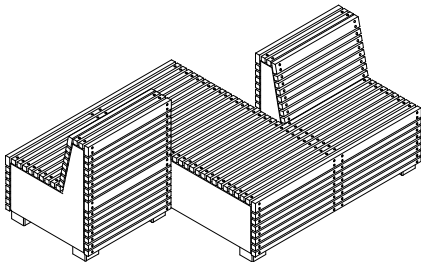

ADD Plus T F

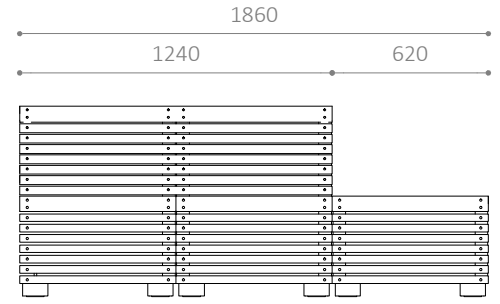
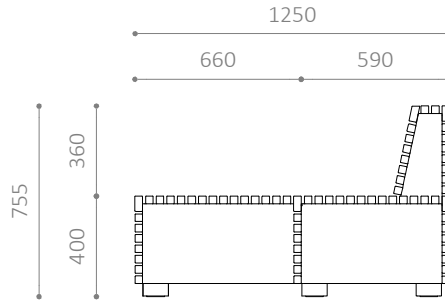
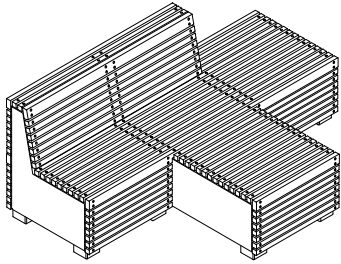

ADD Plus T N

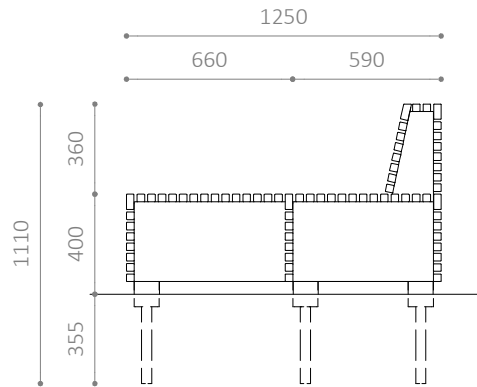
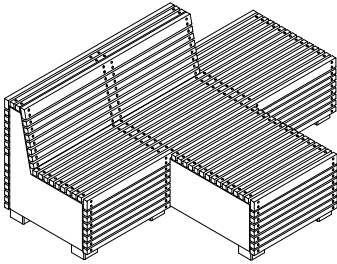

ADD Plus T IF

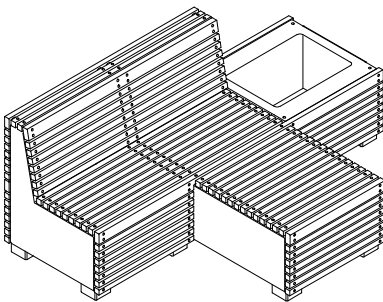

ADD Plus O IF

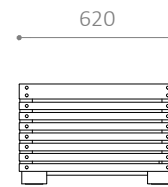
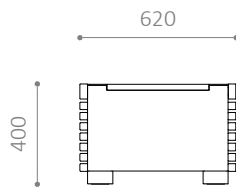
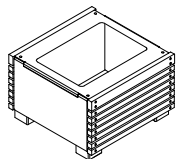

ADD Plus O IN

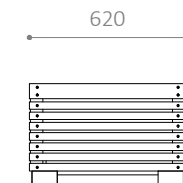
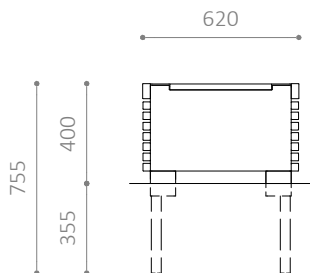
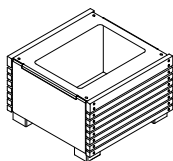

ADD Plus BN B

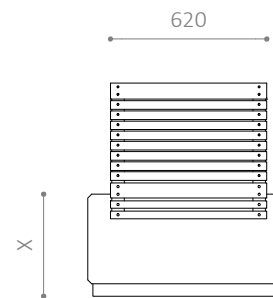
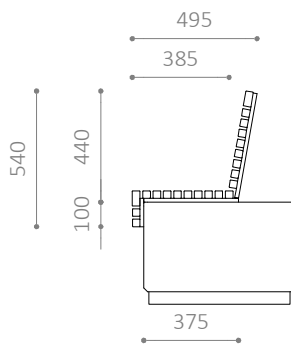
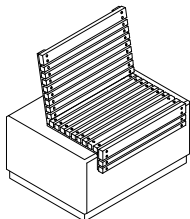

ADD Plus PL B

