



ADD PLUS BÆNKEMODULER

Design: BYMUNCH BY- OG LANDSKABSDESIGN

Serie med bænkemoduler, som kan sammensættes efter behov

Fås også som sæde til eksempelvis betonplint

Fås også i RAL-farver



ADD Plus O F

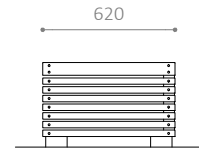
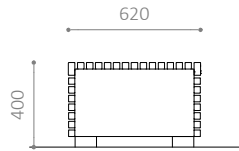
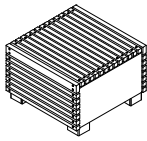

ADD Plus O N

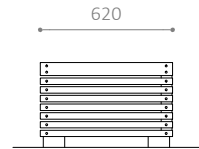
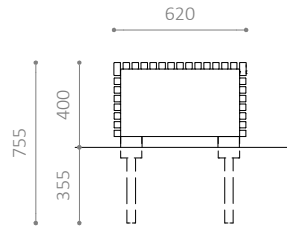
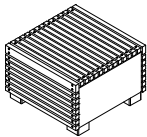

ADD Plus S F

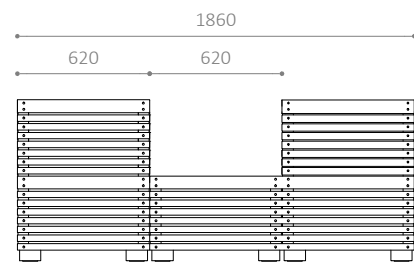
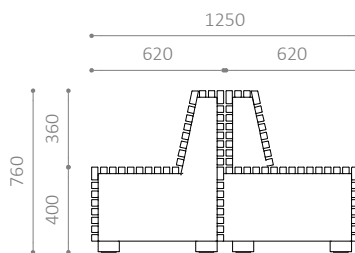
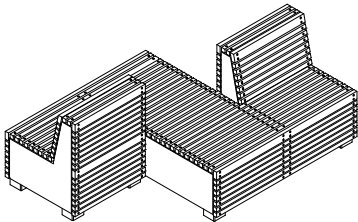

ADD Plus S N

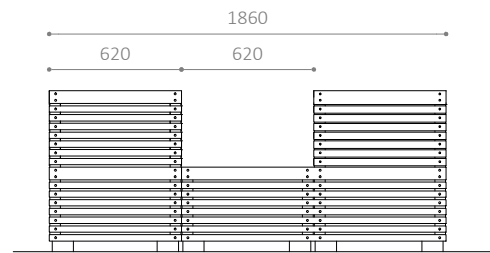
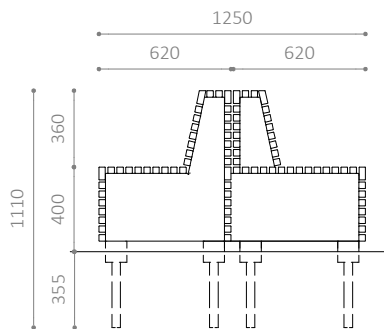
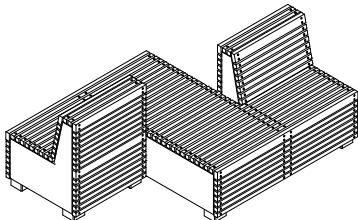

ADD PLUS BÆNKEMODULER

- Serie med bænke moduler, som kan sammensættes efter behov
- Fås også som sæde til eksempelvis betonplint
- Fås også i RAL-farver

MATERIALER:

- Gavle i rustfrit stål
- Grundolieret mahogni (FSC®-certificeret)
- Fås også i ubehandlet mahogni (FSC®-certificeret)
- Varmgalvaniseret stål
- Fås også i pulverlakeret, rustfrit stål

MÅL:

Gavle: 4 mm rustfrit stål
 Ben: 100 x 100 mm firkantstål
 Kantplanker: 60 x 30 mm
 Midterplanker: 30 x 30 mm

MONTERING:

- Nedstøbning
- Anbefalet fundamentstørrelse: $\varnothing 250$ x H400 mm
- Anbefalet siddehøjde: 390 mm



Miljømærket for
 ansvarligt skovbrug

ADD Plus T F

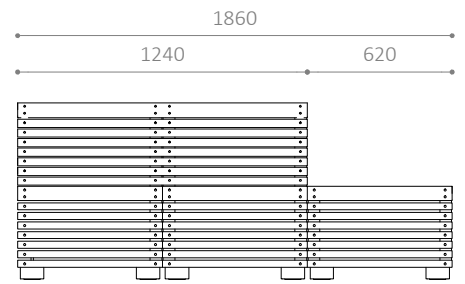
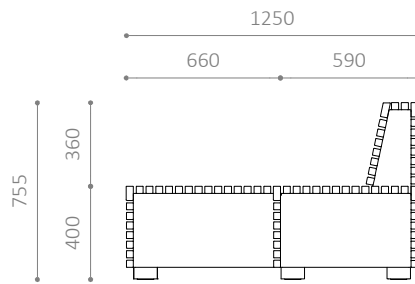
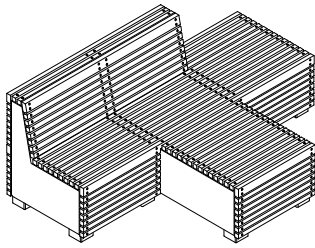

ADD Plus T N

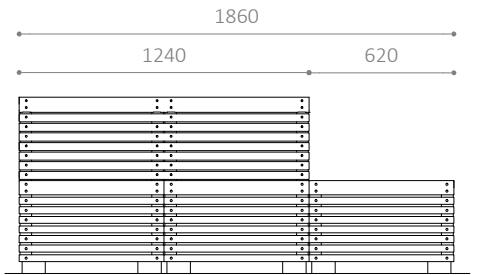
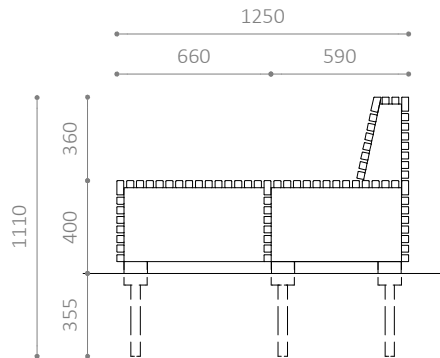
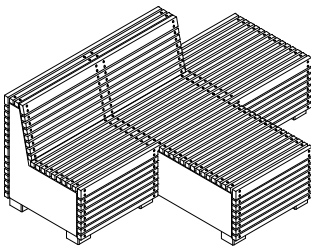

ADD Plus T IF

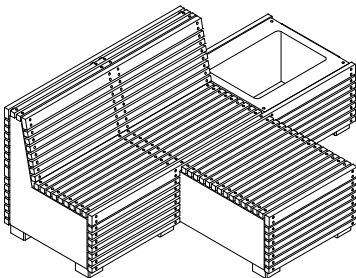

ADD PLUS BÆNKEMODULER

- Serie med bænke moduler, som kan sammensættes efter behov
- Fås også som sæde til eksempelvis betonplint
- Fås også i RAL-farver

MATERIALER:

- Gavle i rustfrit stål
- Grundolieret mahogni (FSC®-certificeret)
- Fås også i ubehandlet mahogni (FSC®-certificeret)
- Varmgalvaniseret stål
- Fås også i pulverlakeret, rustfrit stål

MÅL:

Gavle: 4 mm rustfrit stål
 Ben: 100 x 100 mm firkantstålør
 Kantplanker: 60 x 30 mm
 Midterplanker: 30 x 30 mm

MONTERING:

- Nedstøbning
- Anbefalet fundamentstørrelse: $\varnothing 250 \times H400$ mm
- Anbefalet siddehøjde: 390 mm



Miljømærket for
 ansvarligt skovbrug

ADD Plus O IF

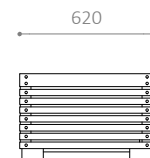
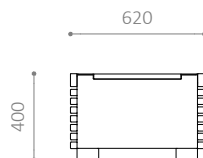
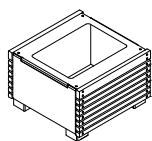

ADD Plus O IN

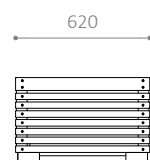
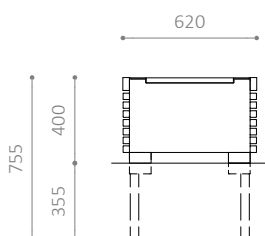
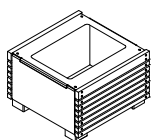

ADD Plus BN B

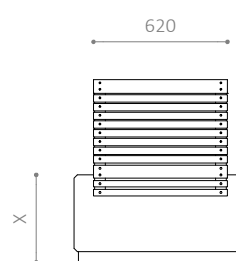
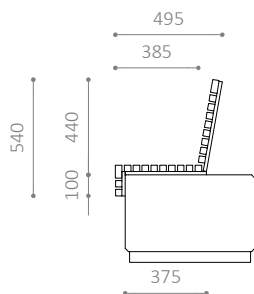
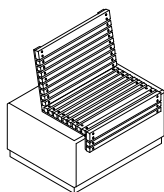

ADD Plus PL B

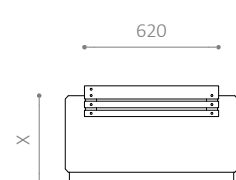
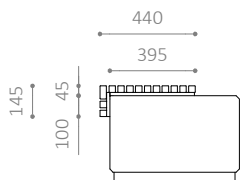
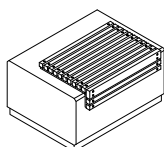

ADD PLUS BÆNKEMODULER

- Serie med bænke moduler, som kan sammensættes efter behov
- Fås også som sæde til eksempelvis betonplint
- Fås også i RAL-farver

MATERIALER:

- Gavle i rustfrit stål
- Grundolieret mahogni (FSC®-certificeret)
- Fås også i ubehandlet mahogni (FSC®-certificeret)
- Varmgalvaniseret stål
- Fås også i pulverlakeret, rustfrit stål

MÅL:

- Gavle: 4 mm rustfrit stål
- Ben: 100 x 100 mm firkantstål
- Kantplanker: 60 x 30 mm
- Midterplanker: 30 x 30 mm

MONTERING:

- Nedstøbning
- Anbefalet fundamentstørrelse: $\varnothing 250$ x H400 mm
- Anbefalet siddehøjde: 390 mm



Miljømærket for
anevareligt skovbrug